

TMM

SERIES

MULTIFUNCTION MULTISCALE TIMER RELAY 4 CONTACTS

APPLICATIONS

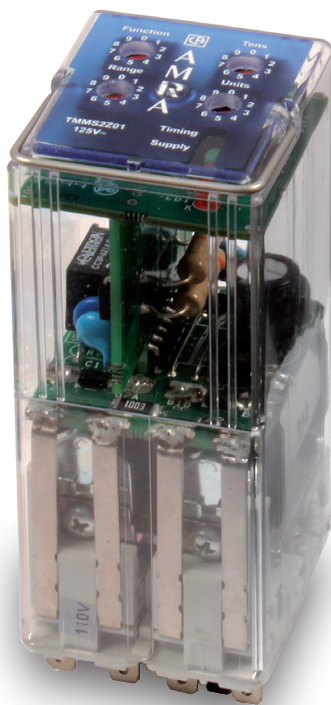

OVERVIEW

- Multifunction, timed, plug-in relay
- 10 different time-delay configurations
- 4 timed or 2 timed + 2 instantaneous contacts
- Wide time setting range: from **0.1s to 99 hours**
Extreme **accuracy across the adjustment range**
- High **EMC immunity**
- Solid and rugged construction for heavy or **intensive duties**
- Independent and self-cleaning contacts
- Magnetic **arc blow-out** as standard
- Separate arc breaking chambers
- Excellent **shocks and vibrations resistance**
- Wide variety of configurations and customizations
- Positive **mechanical keying** for relay and socket

DESCRIPTION

The TMM series is a range of multifunction relays with electronic time delay. They are obtained by assembling the electro-mechanical units of the POKS series with a digital electronic circuit.

The electromechanical part features has the same **reliability** and **ruggedness** of the POKS series.

The PCB design aims to offer the highest reliability as well, thanks to the use of professional and niche components.

A single TMM relay offers **10 different timer functions**, to be **easily set by the user**.

The switching time can be selected within a wide range extending from **0.1 second to 99 hours**, with **extreme accuracy guaranteed across the full scale of adjustment**. This is possible by providing the relay with 10 intermediate scales.

The timer function, the scale and the switching time are adjustable by means of 4 rotary switches, each having 10 positions, located on the front of the relay.

The electronic circuit is immune to high electromagnetic interference, **typical of high voltage electricity transmission stations**.

The construction of the relays and careful choice of the materials are such that they ensure **long life** and considerable ruggedness even in **harsh operating environments** and in the presence of strong **temperature fluctuations**.

Excellent electrical and mechanical performance levels allow the product to be used in the most demanding of sectors such as, for example, rail transport, control and signalling functions in electricity generating stations, electrical transformer stations, or in industries with continuous production processes.

Above all, the excellent ability to withstand shock and vibration allow their use on **rolling stock applications**.

STANDARD COMPLIANCE

| | |
|-----------------|---------------|
| EN 61810-1 | EN 60077 |
| EN 61810-2 | EN 50155 |
| EN 61810-7 | EN 60695-2-10 |
| EN 61373 | EN 61000 |
| EN 45545-2 | EN 60529 |
| ASTM E162, E662 | |

| MODELS | NOMINAL CURRENT | NUMBER OF CONTACTS | | ROLLING STOCK APPLICATION |
|--------|-----------------|--------------------|---------------|---------------------------|
| | | Time-delayed | Instantaneous | |
| TMM2 | 10 A | 2 | 2 | • |
| TMM4 | 10 A | 4 | - | • |

FOR PRODUCT CODE CONFIGURATION, SEE THE "ORDERING SCHEME" TABLE

| COIL DATA | |
|---|---|
| Nominal voltages Un ⁽¹⁾ | DC: 12-24-36-48-72-110-125-132-144-220 AC: 12-24-48-110-127-220-230 |
| Max. consumption at Un | TMM2: 5.5 W / 7.5VA TMM4: 4.5 W / 6.5 VA |
| Operating range ⁽¹⁾ | 80...115% Un |
| Rolling stock version ⁽²⁾⁽³⁾ | DC: 70...125% Un |
| Type of duty | Continuous |
| Drop-out voltage ⁽⁴⁾ | > 15% Un |

(1) Other values on request.

(2) See "Ordering scheme" table for order code.

(3) For operating ranges different to that specified by EN60077, refer to table "Rolling stock versions - Special Ranges".

(4) Limit value for supply voltage, expressed as % of the nominal value, beneath which the relay is certainly de-energized.

| CONTACT DATA | TMM2 | TMM4 |
|--|--|-----------------------|
| Number and type | 2 timed + 2 instantaneous SPDT, form C | 4 timed, SPDT, form C |
| Current | 10 A | |
| Nominal ⁽¹⁾ | 10 A | |
| Maximum peak (1 s) ⁽²⁾ | 20 A (1min) / 40 A (500ms) | |
| Maximum pulse (10 ms) ⁽²⁾ | 150 A | |
| Example of electrical life expectancy ⁽³⁾ | 0.7 A – 132 Vdc – L/R 40 ms : 10 ⁵ operations | |
| 1,800 operations/h | 1 A – 110 Vdc – L/R 0 ms : 10 ⁵ operations | |
| Making capacity | 30 A (for 200 ms) – 110Vdc – L/R 0 ms : 2,000 operations | |
| Minimum load ⁽⁴⁾ | 500 mW (20V, 20 mA) | |
| Standard contacts | 100 mW (10V, 5 mA) | |
| Gold-plated contact P4GEO ⁽⁵⁾ | 50 mW (5V, 5 mA) | |
| Gold-plated contact P8 ⁽⁵⁾ | 250 Vdc / 350 Vac | |
| Maximum breaking voltage | AgCu | |
| Contact material | DC ⁽⁸⁾ – AC | |
| Operating time at Un (ms) ⁽⁶⁾⁽⁷⁾ | ≤ 20 - ≤ 20 | |
| Pick-up (NO contact closing) | ≤ 15 - ≤ 20 | |
| Drop-out (NC contact closing) | | |

(1) On all contacts simultaneously, reduction of 30%.

(2) The max. peak and pulse currents are those currents that can be handled, for a specified time, by the contact. They do not refer to steady or interrupted currents.

(3) For other values, see electrical life expectancy curves.

(4) Values referred to a new product, measured in laboratory. The ability to maintain this performance over the time depends on the environmental conditions and the contact' frequency use. The use of gold plated contacts is recommended in the case of very low loads.

(5) Specifications of contacts on new relay

a. Plating material: **P4 GEO**: gold-nickel alloy (>6μ) **P8**: gold-cobalt alloy (>5μ), knurled contact

b. When the gold-plated contact is subject to heavy loads, it will be degraded on the surface. In such case, the characteristics of the standard contact should be taken into consideration. This does not impair relay operation.

(6) Times for the instantaneous component of the relay (TMM2 model).

(7) Unless specified otherwise, the operating time signifies until stabilization of the contact (including bounces). It should be added to the preset delay time.

(8) Addition of a flyback diode connected in parallel with the coil (DC version only) causes an increase in operating time when the relay drops out.

INSULATION



| | | |
|---|--|-----------------------------|
| Insulation resistance (at 500Vdc) | | |
| between electrically independent circuits and between these circuits and ground | | > 1,000 MΩ |
| between open contact parts | | > 1,000 MΩ |
| Withstand voltage at industrial frequency | | |
| between electrically independent circuits and between these circuits and ground | | 2 kV (1 min) - 2.2 kV (1 s) |
| between open contact parts | | 1 kV (1 min) - 1.1 kV (1 s) |
| between adjacent contacts | | 2.5 kV (1 min) - 3 kV (1 s) |
| Withstand voltage at industrial frequency (1.2/50μs – 0.5J) | | |
| between electrically independent circuits and between these circuits and ground | | 5 kV |
| between open contact parts | | 3 kV |

MECHANICAL SPECIFICATIONS



| | | |
|------------------------|---|---------------------------------|
| | Mechanical life | 10 x 10 ⁶ operations |
| Maximum switching rate | Mechanical life expectancy | 3,600 operations / hour |
| | Degree of protection (with relay mounted) | IP40 |
| | Dimensions (mm) ⁽¹⁾ | 40 x 50 x 97 |
| | Weight (g) | ~ 220 |

1. Output terminals excluded.

ENVIRONMENTAL SPECIFICATIONS



| | | |
|----------------------------------|------------------------------------|--------------------------|
| Operating temperature | Standard | -25° to +55°C |
| | Version for railway, rolling stock | -25° to +70°C |
| Storage and shipping temperature | | -40° to +70°C |
| Relative humidity | Standard: 75% RH | Tropicalized: 95% RH |
| Resistance to vibrations | | 5g - 10 to 55 Hz - 1 min |
| Resistance to shock | | 20g – 11 ms |
| Fire behaviour | | V0 |

STANDARDS AND REFERENCE VALUES



| | |
|------------------------------------|---|
| EN 61810-1, EN 61810-2, EN 61810-7 | Electromechanical elementary relays |
| EN 61812-1 | Timer relays |
| EN 60695-2-10 | Fire behaviour |
| EN 61000 | Electromagnetic compatibility |
| EN 60529 | Degree of protection provided by enclosures |

Unless otherwise specified, the products are designed and manufactured according to the requirements of the above-mentioned European and International standards.

In accordance with EN 61810-1, all items of technical data are referred to ambient temperature 23 °C, atmospheric pressure 96kPa and 50% humidity.

Tolerance for coil resistance, nominal electrical input and nominal power is ±7%.

RAILWAYS, ROLLING STOCK - STANDARDS



| | |
|-----------------|--|
| EN 60077 | Electric equipment for rolling stock. General service conditions and general rules |
| EN 50155 | Electronic equipment used on rolling stock |
| EN 61373 | Shock and vibration tests, Cat 1 Class B |
| EN 45545-2 | Fire behavior, Cat E10, Requirement R26, V0 |
| ASTM E162, E662 | Fire behaviour |

RAILWAYS, ROLLING STOCK – SPECIAL OPERATING RANGES⁽¹⁾



| Nominal voltage | Minimum pick-up voltage | Maximum operating voltage | Order symbol ⁽¹⁾ |
|-----------------|-------------------------|---------------------------|-----------------------------|
| 24 Vdc | 16.8 | 32 | Z01 |
| 72 Vdc | 55 | 104 | Z01 |
| 110 Vdc | 77 | 144 | Z01 |

(1) To request the special range, indicate the "Z0x" symbol in the "Keying position" field in the "Ordering scheme" table.

The special range may be subject to operating specifications different from standard specifications. Please contact us for further information.



CONFIGURATIONS - OPTIONS

| | |
|----------------------|---|
| P2 | Tropicalization of the coil with epoxy resin for use with 95% RH (@ T 50 °C). This treatment also protects the coil against corrosion which could occur by combination of the humidity with certain chemical agents, such as those found in acid atmospheres (typical of geothermal power stations) or saline atmospheres |
| P4GEO | Gold plating of contacts with gold-nickel alloy, thickness $\geq 6\mu$. This treatment ensures long-term capacity of the contact to conduct lower currents in harsh ambient conditions such as acid atmospheres (typical of geothermal power stations) or saline atmospheres |
| P5GEO | P4GEO gold-plating of contacts + P2 coil tropicalization |
| P6GEO | P4GEO type gold-plating, but applied to contacts, contact terminal and output terminals + P2 coil tropicalization |
| P7 | AgCdO (silver cadmium oxide) contacts. |
| P8 | Gold plating of contacts with gold-cobalt alloy, thickness $\geq 5\mu$, knurled fixed contact. This finish allows further improvement of the gold-plated contact performance compared to the treatment P4GEO. |
| P9 | P7 + Neodymium Magnetic arc blow-out. Neodymium magnet is strong permanent magnet made from an alloy of neodymium, iron & boron; Increases the electrical life expectancy by about 30%. |
| FLYBACK DIODE | Polarized component connected in parallel with the coil (type 1N4007 or BYW56 for rolling stock version) designed to suppress overvoltages generated by the coil when de-energized. |
| TRANSIL | Non-polarized component connected in parallel with the coil. Behaviour is similar to that of a varistor, with faster operating times. |



ORDERING SCHEME

| PRODUCT CODE | APPLICATION ⁽¹⁾ | CONFIGURATION A | CONFIGURATION B | TYPE OF POWER SUPPLY | NOMINAL VOLTAGE (V) ⁽²⁾ | KEYING POSITION ⁽³⁾ |
|--------------|--|---|--|--------------------------------------|---|--------------------------------|
| TMM2 TMM4 | E: Energy F: Railway Fixed Equipment R: Railway Rolling Stock | 1: Standard 2: Diode // 3: Varistor 7: Transil | 0: Standard 2: P2 4: P4 GEO 5: P5 GEO 6: P6 GEO 7: P7 8: P8 9: P9 | C: Vdc A: Vac 50 Hz | 012 - 024 - 036 048 - 072 - 100 110 - 125 - 127 132 - 144 - 220 230 | XXX |

Example

| | | | | | | |
|--|----------|----------|----------|----------|------------|--|
| TMM2 | E | 1 | 8 | C | 024 | |
| TMM2E18-C024 - TMM2 relay, ENERGY series, nominal voltage 24 Vdc, with P8 finish (gold-plated contacts) | | | | | | |
| TMM4 | R | 1 | 0 | C | 110 | |
| TMM4R10-C110 - TMM4 relay, ROLLING STOCK series, nominal voltage 110 Vdc | | | | | | |

(1) **ENERGY:** all applications except for railway. Suitable on energy production, transport and distribution plants, railways fixed equipment, petrochemical and heavy industry.

RAILWAYS, FIXED EQUIPMENT: application on fixed power systems and electrical railway traction.

Construction according to RFI (FS Group) specification no. RFI DPRIM STF IFS TE 143 A, if applicable.

For list of RFI compliant and type-approved products, consult dedicated catalogue "RAILWAY SERIES – RFI APPROVED".

RAILWAYS, ROLLING STOCK: Application on board rolling stock (rail-tram-trolley vehicles). Electrical specifications according to EN60077.

Also available is the **STATIONS** series, with ENEL approved material meeting LV15/LV16 specifications.

For list of ENEL compliant and type-approved products, consult dedicated catalogue "STATIONS SERIES – LV15-LV16-LV20".

(2) Other values on request.

(3) Optional value. The positive mechanical keying is applied according to the manufacturer's model.

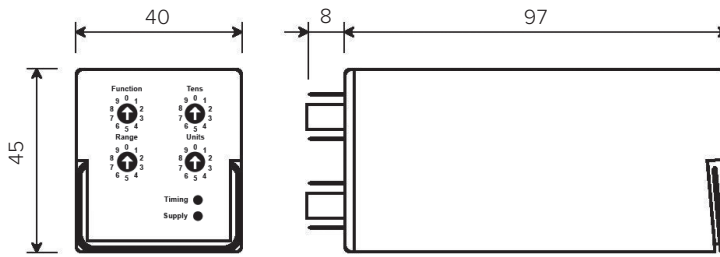

Timing = Green Led: time delay activated
 Supply = Red Led: auxiliary power on

WIRING DIAGRAM

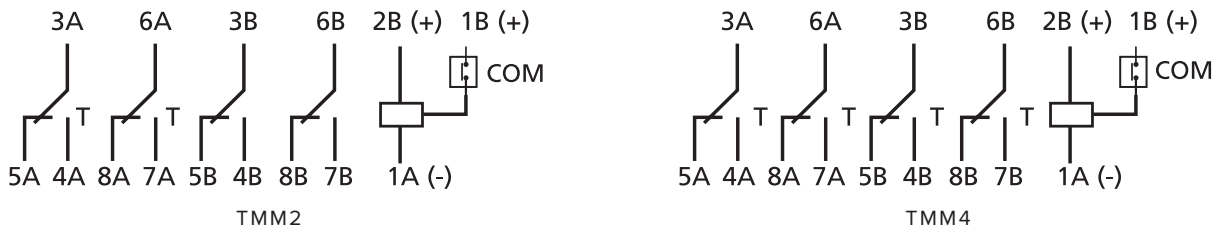

T= time delay contacts

Terminals 2B and 1A are allocated to the auxiliary power supply.

Terminal 1B is allocated to CONTROL. The negative of the control circuit is common with that of the auxiliary power supply.

Certain functions require an auxiliary power supply to guarantee operation of the time delay (terminal 2B).

TIME DELAY – SWITCHING TIME SETTING



| | | |
|---|---|------------------------------------|
| Controls setting function, range and time | 4 rotary switches with 10 positions (0...9) | |
| Time setting range | 100 ms...99 h | |
| Intermediate scales | 10, from 9.9 seconds to 99 hours | |
| Resolution of switching time setting | 1% of intermediate scale | |
| Accuracy, time delay (0.8...1.1 Un, t=20°C) | DC : ± 1% of selected time or ± 10 ms ⁽¹⁾ AC : ± 1% of selected time; 0,1s...10s: ± 2% ± 20ms | |
| Accuracy, repeatability | DC : ± 0.5% | AC : ± 0.5% + 20 ms |
| Reset | < 200ms | during time delay interval < 400ms |
| Control signal "COM" | > 10 ms | |

(1) Whichever of the two values is higher. Excluding contact switching time.

The function and switching time are adjustable by means of 4 rotary-switch located on the front of the relay, each having 10 positions, with which the user can select time delay settings between 100 ms and 99 hours.

The position of the arrow point on each rotary switch indicates the number selected.

Adjustments are made by discrete steps, which means that no intermediate settings are possible.

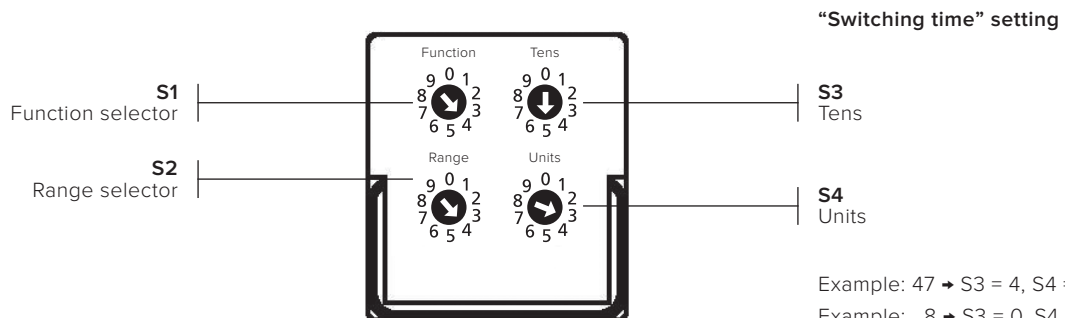

Example: 47 → S3 = 4, S4 = 7
 Example: 8 → S3 = 0, S4 = 8

ADJUSTMENT OF SWITCHING TIME (EXCEPT FOR FUNCTION F5)

To adjust the switching time, the first step is to adjust the intermediate scale T(s), by selecting one of the 10 available scales using the S2 rotary switch. The values available are given in table 1.

| Scale | Minimum value | Maximum value | Step |
|-------|---------------|---------------|-------|
| 0 | 0.1s | 9.9s | 100ms |
| 1 | 1s | 99s | 1s |
| 2 | 3s | 297s | 3s |
| 3 | 5s | 495s | 5s |
| 4 | 10s | 990s | 10s |

| Scale | Minimum value | Maximum value | Step |
|-------|---------------|---------------|-------|
| 5 | 1min | 99min | 1min |
| 6 | 3min | 297min | 3min |
| 7 | 5min | 495min | 5min |
| 8 | 10min | 990min | 10min |
| 9 | 1h | 99h | 1h |

Table 1 – Available scales

Next, the switching time is adjusted by means of rotary-switch selectors S3 and S4.

The combination of these two 10-position controls, located on the right, allows the selection of a number between 1 and 99.

The number selected with the “Tens” arrow combined with the number selected with the “Units” arrow represents the multiplier of the step selected via the “Range” control. The resulting value gives the time used by the relay in operation.

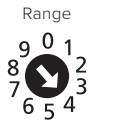

Range

Example of setting “4”.
Minimum value 10s, maximum value 990s.
The step setting is 10s.

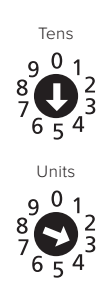

Tens

Units

Example of setting “53”.

The scale selected previously is number 4, which has an adjustment step of 10s.

The time used by the relay in operation will be:
 $53 \times 10s = 530$ seconds



Setting's changes have to be operate with relays switched off.
Setting's changes with energized relay have no effect.

ADJUSTMENT OF SWITCHING TIME FOR FUNCTION F5 – ASYMMETRIC FLASH

Function F5 pilots an asymmetric flash. The “ON” time and the “OFF” time are adjustable independently

“ON” time (t) → selector S4

“OFF” time (T) → selector S3

In this instance, selector S3 and selector S4 are both calibrated in UNITS. Position “0” assumes the value of 10 integers.

Once the scale has been set by means of selector S2, selectors S3 and S4 are used to set the number that will provide the multiplier for the step of the selected scale.

Example: S2 = 1 → unit of time : seconds

S4 = 3 → t = 3 seconds

S3 = 0 → T = 10 seconds

SELECTING THE FUNCTION

The function is selected by positioning the arrow of selector S1 so that the point is aligned with the number of the required function.

| FUNCTION | DESCRIPTION |
|----------|--|
| F0 | Time delay on pick-up. |
| F1 | Time delay on drop-out. Instantaneous contacts follow the status of the auxiliary power supply. |
| F2 | Time delay on drop-out, instantaneous contacts on "CONTROL". Instantaneous contacts follow the status of the control signal. |
| F3 | One-shot function. |
| F4 | Flasher, symmetrical. The "ON" time and the "OFF" time are the same. |
| F5 | Flasher, asymmetrical. The "ON" time and the "OFF" time are different, and adjustable independently. |
| F6 | One-shot function on "CONTROL". The timing cycle starts on activation of the control signal. |
| F7 | One-shot function with fixed pulse (3s), delayed at pick-up. Pulse delay adjustable. |
| F8 | One-shot function, on "CONTROL", with fixed pulse (3s), delayed at pick-up. The timing cycle starts on activation of the control signal. Pulse delay adjustable. |
| F9 | Step function. |

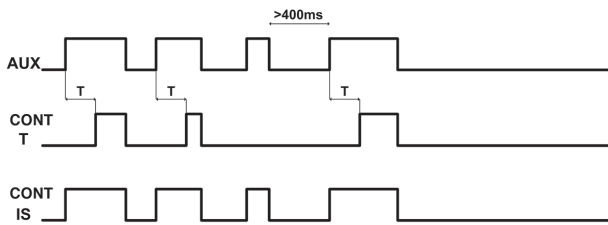

F0 – Time delay on pick-up.

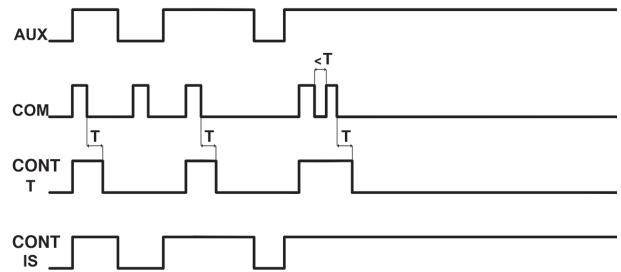

F1 – Time delay on drop-out, instantaneous contacts follow the status of the auxiliary power supply.

The instantaneous contacts follow the status of the auxiliary power supply (2B terminal).

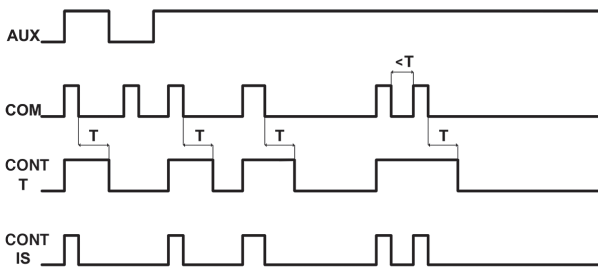

F2– Time delay on drop-out.

The instantaneous contacts follow the status of the control signal ("COM", 1B terminal).

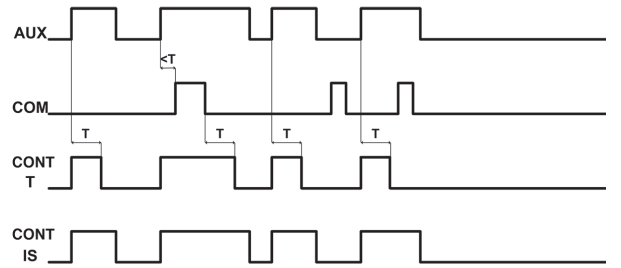

F3 – One-shot function.

The control signal ("COM", 1B terminal) resets the time "t", on drop-out.

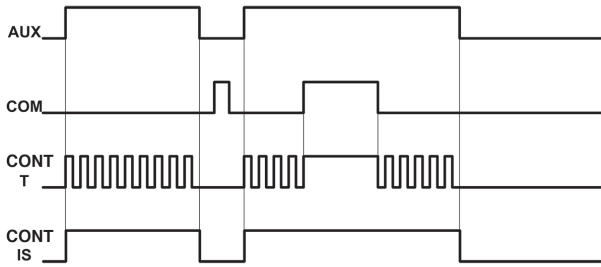

F4 – Flasher, symmetrical.

The control signal ("COM", 1B terminal) stops the flash.

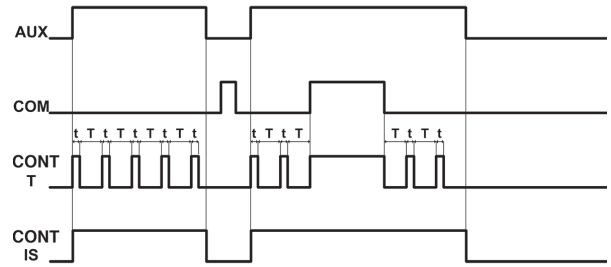

F5 – Flasher, asymmetrical.

The control signal ("COM", 1B terminal) stops the flash t and T are adjustable using the same unit of time.
 Example: S2 = 1 → unit of time: seconds
 S4 = 3 → t = 3 seconds
 S3 = 0 → T = 10 seconds

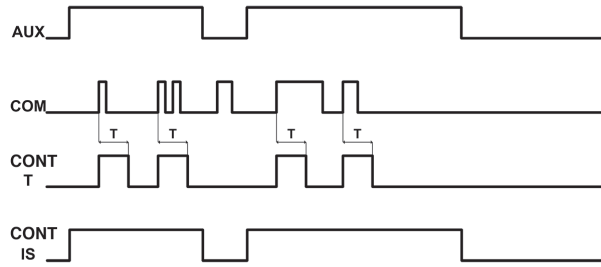

F6 – One-shot function on "CONTROL" (COM).

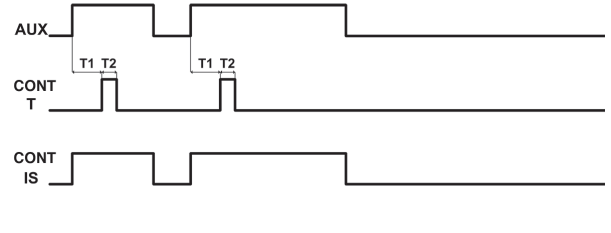

F7 – One-shot function with fixed pulse (3s), delayed at pick-up.

T1: adjustable by way of selector S3 / S4
 T2 : fixed, 3 seconds

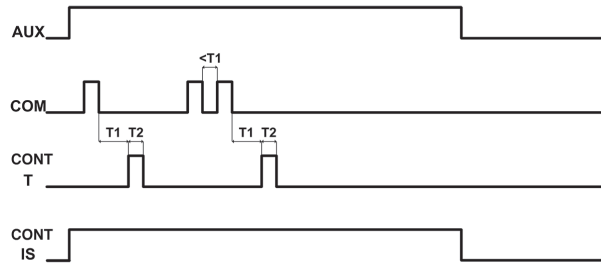

F8 – One-shot function, on "CONTROL", with fixed pulse (3s), delayed at pick-up.

T1: adjustable by way of selector S3 / S4
 T2 : fixed, 3 seconds
 Control signal ("COM", 1B terminal) starts time delay T1
 Control signal ("COM", 1B terminal) restarts the time, if this appears during the time delay.

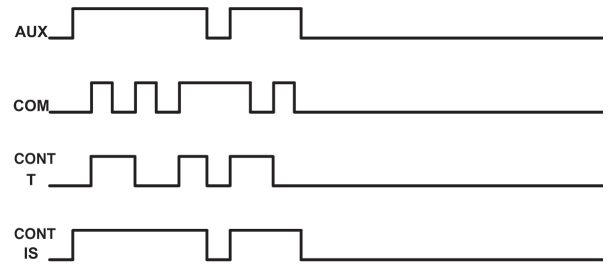

F9 – Step function

The S3 and S4 switches have no effect on the relay operation.

Applicable note for all operations diagrams:

- AUX: 2B - 1A terminals
- COM: 1B terminal
- CONT T: timed contacts
- CONT I: instantaneous contacts

See "Wiring diagram" to identify the instantaneous and timed contacts terminals'.

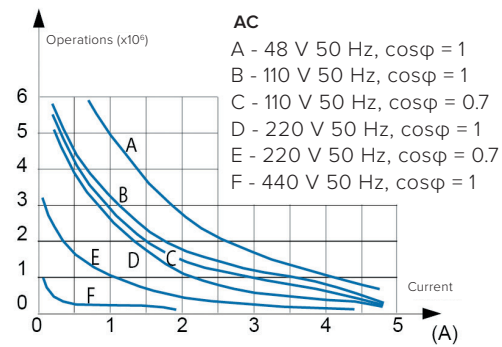
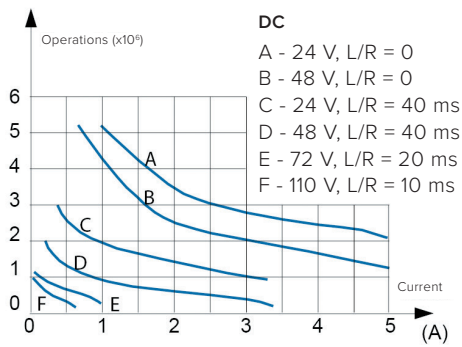
**Some examples of electrical life expectancy**

12Vdc - 10 A - Resistive : 10⁶ operations
48Vdc - 5 A - L/R 10 ms : 5 x 10⁵ operations
80Vdc - 5 A - Resistive : 5 x 10⁵ operations
110Vdc - 0.5 A - L/R 10 ms : 5 x 10⁵ operations
110Vdc - 1 A - L/R 0 ms : 10⁵ operations

132 Vdc - 0.7 A - 132 Vdc - L/R 40 ms : 10⁵ operations
220Vdc - 0.2 A - L/R 10 ms : 10⁵ operations
110Vac - 5 A - Cosφ 0.7 : 5 x 10⁵ operations
220Vac - 3 A - Cosφ 0.7 : 5 x 10⁵ operations
440Vac - 0,2 A - Resistive : 5 x 10⁵ operations

(1) Switching frequency 1,200 operations/hour, cycle 50%.

SOCKETS AND RETAINING CLIPS

| Number of terminals (standard dimensions 5x0.8 mm) | 16 | Retaining clip |
|--|---------------|----------------|
| For wall or rail mounting | | |
| Spring clamp, wall or DIN H35 rail mounting | PAIR160 | RT48 |
| Screw, wall or DIN H35 rail mounting | 48BIP20-I DIN | RT48 |
| Screw, wall mounting | 48BL | RT48 |
| For flush mounting | | |
| Spring clamp | PRIR160 | RT48 |
| Double faston (4.8 x 0.8 mm) | ADF2 | RT48 |
| Screw | 43IL | RT48 |
| For mounting on PCB | | |
| | 65 | |

(1) Insert the clip before fastening the socket on the panel.
For more details, see specifications of mounting accessories.

INSTALLATION, OPERATION AND MAINTENANCE**Installation**

Before installing the relay on a wired socket, disconnect the power supply.

The preferential mounting position is on the wall, with the relay positioned horizontally in the "reading orienting" of marking so that the label is readable in the correct sense.

Spacing: the distance between adjacent relays depends on use' conditions.

If a relay is used in the "less favorable" conditions that occur with "simultaneously":

- Power supply: the maximum allowed, permanently
- Ambient temperature: the maximum allowed, permanently
- Current on the contacts: the maximum allowed, permanently
- Number of contacts used: 100%

it is strongly recommended to space relay at least 5 mm horizontally and 20 mm vertically, to allow for proper upward heat' dissipation and increase the longevity of the component.

Actually, relays could be used in less severe conditions. In this case, the distance between adjacent relays can be reduced or abolished. A correct interpretation of the use' conditions allows the optimization of the available spaces. Contact AMRA for more information.

To increase relay' longevity, we recommend mounting relays intended for "continuous use" (permanent power supply), alternating them with relays intended for less frequent use.

For a safe use, the retaining clip is recommended.

For use on rolling stock, relays have been tested to EN 61373 standard equipped with retaining clip(s).

Operation

Before use: if relay is not used, for example after long storage periods, contact resistance may increase due to a natural and slight oxidation or polluting deposits.

In order to restore the optimal conductivity and for standard contacts (**NOT gold plated**) it is recommended to switch several time a load of at least 110Vdc - 100mA or 24Vdc - 500mA. The contacts will be "cleaned" thanks to the electric arc generated during the current interruption and the mechanical self-cleaning action.

The common contact rubs against the fixed poles (NO and NC contacts) both when opening and when closing, which ensures a self-cleaning action.

An increase in contacts' resistance, in most cases, does not represent a problem. Many factors contribute to the correct use of contact and consequently to the relay' long-term reliability:

- **Load:** the current switching generates an electric arc with cleaning effects. For proper electrical cleaning and performance keeping we recommend:
 - o Standard contacts: Minimum current = 20mA
 - o Gold plated contacts: Minimum current = 10mA
- **Operating frequency:** relays are components that can operate with a wide range of switching frequency. High frequency operation also allows a continuous cleaning effect by "sliding" (mechanical cleaning). In case of low frequency operation (for example few time a day), we advise:
 - o Use of contact with currents twice compared to those indicated.
 - o For currents lower than 10mA, use gold plated contacts and connect 2 contacts in parallel, in order to reduce the equivalent contact resistance.
- **Pollution:** the presence of pollution can cause impurities on contact surface. Electric charges attract organic molecules and impurities that are deposited on the contact surface. Electrical and mechanical cleaning, respectively, burn and remove such impurities. In pollution presence, the minimum recommended currents must be respected. In extreme cases, provide double the cleaning current.

Condensation is possible inside the relay when energized and the outside ambient temperature is cold; this is quite normal and does not affect the operation of the relay. Plastic materials of relay do not possess hygroscopic properties.

Maintenance

No maintenance is required.

In case of normal relay wear (reaching the end of electrical or mechanical life), the relay cannot be restored and must be replaced.

To check the component, relay removal must be carried out with slight lateral movements. An "up and down" movement can cause terminals damage.

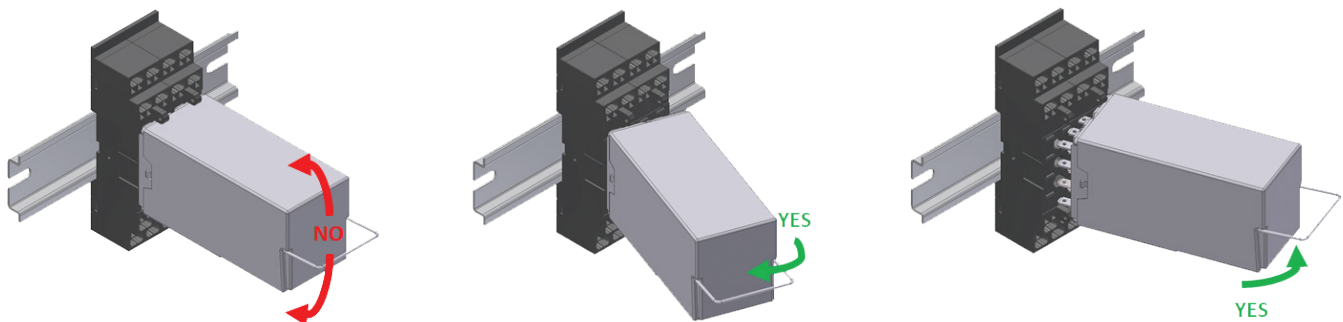

Often the malfunctions are caused by power supply with inverted polarity, by external events or by use with loads exceeding the contact performance.

In case of suspected malfunction, energize relay and observe if mechanical operation of contacts / relay mechanism is performed. Pay attention to the power supply polarity, if relay is equipped with polarized components (example: diode, led).

- In case of expected operation, clean the contacts (see paragraph "OPERATION") and check if the circuit load ranges within the contact performance. If necessary, replace with relays with gold contacts. Note: the electrical continuity of contacts must be checked with adequate current.
- If it does not work, we recommend to use a relay of the same model and configuration.

If an investigation by AMRA is required, pull-out the relay from the socket, don't remove the cap, avoid any other manipulation and contact us. You will be asked for the following data: environmental conditions, power supply, switching frequency, contact load, number of operations performed.

The fault can be described through the "TECHNICAL SUPPORT" section of the website www.amra-chauvin-arnoux.it.

In any case, the relay cannot be repaired by the user.

Storage

Storage conditions of the materials awaiting use must guarantee the environmental conditions (temperature, humidity and pollution) required for the product conservation, in order to avoid deterioration.

The product must be stored in an environment sheltered from atmospheric agents and not polluted, with an ambient temperature between -40 and +70°C with max 75% RH. Humidity can reach peaks of 95%. In any case, there must be no condensation. Before use, please read carefully "OPERATION" section.